

Tous droits strictement réservés. Reproduction ou communication à des tiers interdite sous quelque forme que ce soit sans autorisation écrite du propriétaire. Property of FCI. Droits de reproduction FCI.

All rights strictly reserved. Reproduction or issue to third parties in any form whatever is not permitted without written authority from the proprietor. Property of FCI. Copyright FCI.

PRODUCT NO
SEE TABLE

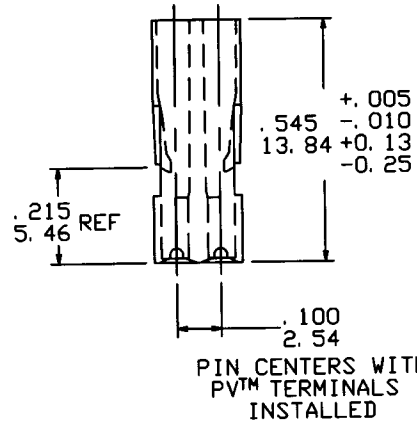
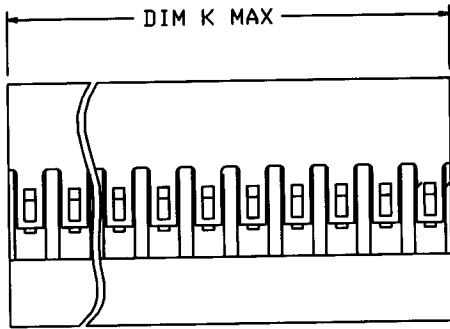

NOTES

- ① MOLDING MAT'L: MODIFIED POLYPHENYLENE OXIDE (NORYL). COLOR - BLACK, MEETING UL 94V-0.
2. PIN LENGTH TO BE .210/5.33 MIN. RECOMMENDED PIN LENGTH IS .225±.015/5.72±0.38.
3. FOR TERMINAL APPLICATION SEE TA-531.
4. TERMINALS MUST BE CRIMPED PROPERLY FOR SATISFACTORY LATCHING. SEE TA-75 FOR CRIMPING INSTRUCTIONS.
5. THIS HOUSING IS INTENDED FOR USE WITH BERG MINI PVTM TERMINAL WITH 22-36 GAUGE WIRE.
- ⑥ ALL MARKINGS EXCEPT LOGO USE 6 POINT TYPE (APPROX .06/1.52 HIGH) AND WHITE INK (MARKEM #8829 OR EQUIV.) WHEN MARKING CAVITIES. NUMERALS OR LETTERS ARE TO BE CENTERED ON RESPECTIVE CAVITIES, UNLESS OTHERWISE NOTED.
- ⑦ LOGO TO BE POSITIONED IN THIS AREA SO THAT IT IS READ FROM THE SAME EDGE OF THE CONNECTOR AS THE OTHER MARKINGS.
- ⑧ ALL MARKINGS FOR MILITARY PART NUMBERS ARE TO BE PER MIL-STD-1285 SEE TABULATION.
- ⑨ PLACE DESC P/N AND CAGE NO. ON PACKAGING LABEL. PRODUCT LENGTH IS TOO SMALL TO MARK PRINT.

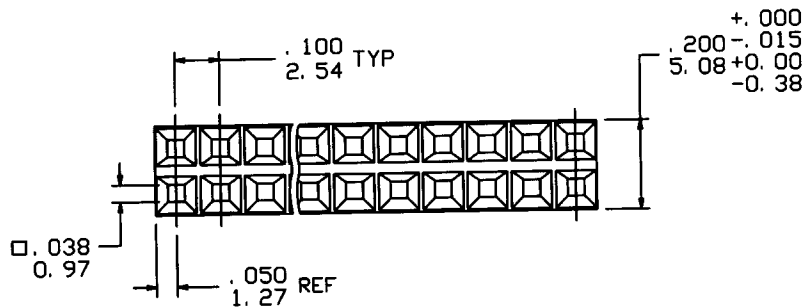

mat'l. code				tolerances unless otherwise specified				CUSTOMER COPY			FCI Electronics www.fciconnect.com		
ltr	ecn no	dr	date	linear	.XX ±.01/.3	.XXX ±.005/0.13	.XXXX ±.0020/0.051	projection	title				
AT	V23480	JWB	10/27/92						MINI LATCH HOUSING				
AU	V23825	JWB	11/19/92						DOUBLE ROW .100/2.54 C.C.				
AV	V50128	GAH	3/16/95	angles	0° ±2'			scale	product family LATCH HOUSINGS (67)				
AW	V51031	LSS	9/5/95	dr	M. CLOUSER	1/31/91		2.5:1	size dwg no				
AX	C60092	EPK	6/26/96	enr	C. TREXLER	1/31/91		A	65043				
AY	V90974	BKB	6/9/99	chr	C. TREXLER	1/31/91			sheet 1 of 11				
				appd	C. TREXLER	1/31/91							
sheet index	revision	AY	AY	AY	AY	AY	AY	AY	AY	AY	AY	AY	
sheet		1	2	3	4	5	6	7	8	9	10	11	

cage code
22526

ACAD





PDM: Rev:AY

STATUS: Released

Printed: Aug 02, 2002

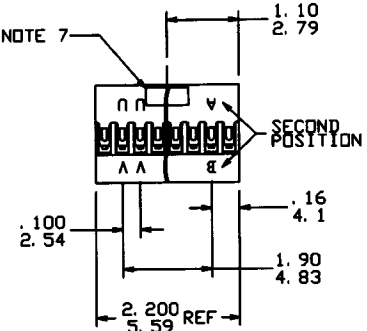
Tous droits strictement réservés. Reproduction ou communication à des tiers interdite sous quelque forme que ce soit sans autorisation écrite du propriétaire. Propriété de FCI. Droits de reproduction FCI.

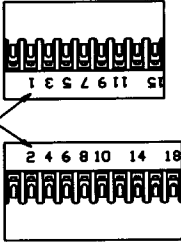
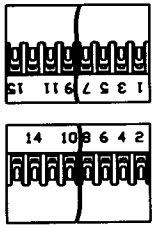
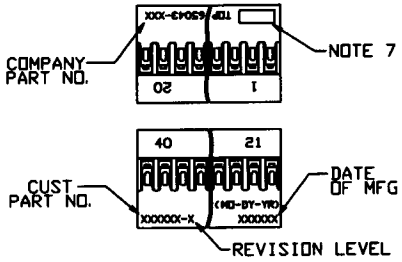
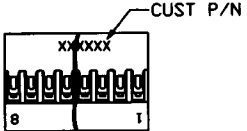
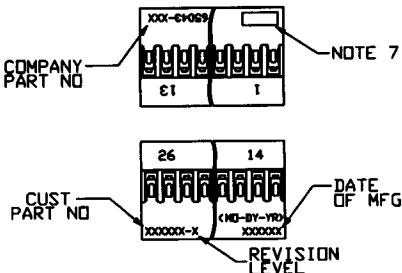
All rights strictly reserved. Reproduction or issue to third parties in any form whatever is not permitted without written authority from the proprietor. Property of FCI. Copyright FCI.

PRODUCT NO SEE TABLE MARK POSITION ONE AND CUST. NAME AS SHOWN.  STYLE A MARK LOGO AND POSITIONS AS SHOWN  STYLE B MARK ARROW IN WHITE AS SHOWN ON SURFACE OPPOSITE GATE.  STYLE C	1 2 MARK POSITION NUMBERS AS SHOWN TO LENGTH OF PART.  STYLE D MARK POSITIONS AS SHOWN.  STYLE E	3 4 MARK TOP, CO. LOGO, CUST P/N REV LEVEL, DATE OF MFG, SECOND & NEXT TO LAST POS ON BOTH SIDES IN WHITE AS SHOWN.  STYLE G MARK CUST P/N & FIRST & LAST POS (1 SIDE ONLY) AS SHOWN  STYLE H MARK TOP, CO. LOGO, CUST P/N REV LEVEL, DATE OF MFG, SECOND & NEXT TO LAST POS ON BOTH SIDES IN WHITE AS SHOWN.  STYLE J MARK SECOND CAVITY AS SHOWN.  STYLE L
--	---	---

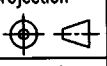
mat'l. code				tolerances unless otherwise specified		CUSTOMER COPY		 Electronics www.fciconnect.com	
ltr	ecn no	dr	date	linear	.XX ±.01/.3	projection	title MINI LATCH HOUSING DOUBLE ROW .100/2.54 C.C.		
AY				linear	.XXX ±.005/0.13	 INCH/MM	product family LATCH HOUSINGS (67)		code
				angles	.XXXX ±.0020/0.051		size 65043	sheet 2 of	
				dr	M. CLOUSER 1/31/91	scale	A		
				engr	C. TREXLER 1/31/91	1:1			
				chr	C. TREXLER 1/31/91				
				appd	C. TREXLER 1/31/91				
sheet index	revision sheet								

cage code
22526

Tous droits strictement réservés. Reproduction ou communication à des tiers interdite sous quelque forme que ce soit sans autorisation écrite du propriétaire. Propriété de FCI. Droits de reproduction FCI.



All rights strictly reserved. Reproduction or issue to third parties in any form whatever is not permitted without written authority from the proprietor. Property of FCI. Copyright FCI.

PRODUCT NO
SEE TABLE

MARK CO. LOGO, CUST P/N AND FIRST & LAST POS PLUS EVERY FOURTH POS IN WHITE AS SHOWN (ONE SIDE ONLY)

NOTE: HOUSING WITH 16 POS OR LESS WILL NOT HAVE CO. LOGO INCLUDED.

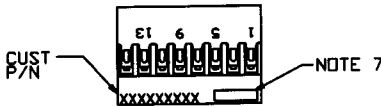

STYLE M

MARK CAV IDENTIFICATION APPROX AS SHOWN. (ONE SIDE ONLY)



STYLE N

MARK CAVITY AS SHOWN WITH ARROW.

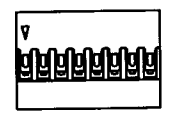

STYLE O

MARK CHARACTERS AS SHOWN IN WHITE. (ONE SIDE ONLY)

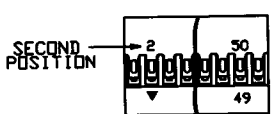

STYLE P

MARK CHARACTERS AS SHOWN IN WHITE. (ONE SIDE ONLY)

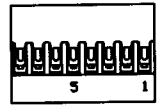

STYLE Q

CO. LOGO AND P/N MARKED AS SHOWN. NO CO. P/N ON HOUSING LESS THAN 2 X 8.

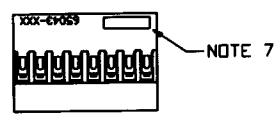

STYLE R

MARK CHARACTERS IN WHITE AS SHOWN.



STYLE S

MARK CHARACTERS IN WHITE AS SHOWN.



STYLE T

MARK CHARACTERS ONE SIDE ONLY.



STYLE U

NUMBER EVERY OTHER POSITION AND SIDE A AND B AS SHOWN.

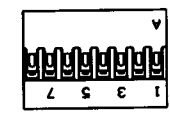

STYLE V

MARK POS 1 & 26 CO. LOGO & P/N AS SHOWN SEE NOTE 6.

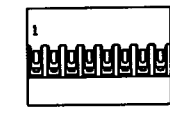

STYLE W

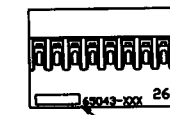

STYLE Z

MARK POSITION IDENTIFICATION AS SHOWN.

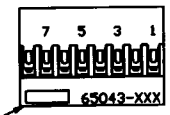

NOTE 7



STYLE Y

MARK POSITIONS 1, 2 AND 3 ONLY SEE NOTE 6



mat'l. code				tolerances unless otherwise specified		CUSTOMER COPY		Electronics www.fciconnect.com	
ltr	ecn no	dr	date	linear	.XX ±.01/.3	projection	title		
AY					.XXX ±.005/0.13		MINI LATCH HOUSING		
				angles	.XXX ±.0020/0.051		DOUBLE ROW .100/2.54 C.C.		
				dr	M. CLOUSER 1/31/91	INCH/MM	product family	LATCH HOUSINGS (67)	code
				engr	C. TREXLER 1/31/91	scale 1:1	size	dwg no	sheet
				chr	C. TREXLER 1/31/91		A	65043	3 of
				appd	C. TREXLER 1/31/91				
sheet index	revision sheet						cage code	22526	

Tous droits strictement réservés. Reproduction ou communication e des tiers interdite sous quelque forme que ce soit sans autorisation écrite du propriétaire. Propriété de c FCI. Droits de reproduction FCI.

All rights strictly reserved. Reproduction or issue to third parties in any form whatever is not permitted without written authority from the proprietor. Property of FCI. Copyright FCI.

<p>PRODUCT NO</p> <p>SEE TABLE</p> <p>NUMBER TO BE LOCATED IN CENTER OF RESPECTIVE POSITION</p> <p>STYLE AA</p>	<p>MARK FIRST AND LAST POSITION WITH APPROPRIATE NO. ALL EVEN # POSITIONS ON SAME SIDE OF HOUSING</p> <p>STYLE AD</p>	<p>NUMBER EVERY OTHER POSITION AND SIDE A AND B AS SHOWN. MARK CHARACTERS IN WHITE.</p> <p>STYLE AG</p>	
<p>MARK ENTIRE SURFACE WHITE</p> <p>STYLE AB</p>	<p>MARK FIRST AND LAST POSITION WITH APPROPRIATE NO. BOTH SIDES ALL EVEN # POSITIONS ON SAME SIDE OF HOUSING</p> <p>STYLE AE</p>	<p>MARK NUMBERS IN WHITE.</p> <p>STYLE AH</p>	<p>MARK "THIS SIDE UP" AND POSITION NUMBERS 13 & 24 AS SHOWN IN .060/1.52 HIGH CHARACTERS.</p> <p>STYLE AK</p>
<p>IDENTIFY POSITIONS 1, 6, 13 WITH WHITE CHARACTERS LOCATED AS SHOWN.</p> <p>STYLE AC</p>	<p>MARK HOUSING (ONE SIDE ONLY) EVERY SECOND POSITION WITH ODD NUMBERS TO LENGTH OF PART DO NOT MARK END POSITIONS</p> <p>STYLE AF</p>	<p>MARK FIRST AND LAST POSITION BOTH SIDES AS SHOWN. TO LENGTH OF PART.</p> <p>STYLE AJ</p>	<p>MARK FIRST AND LAST POSITION WITH APPROPRIATE NO. ON ONE SIDE. ALSO PRINT "THIS SIDE UP-1" AS SHOWN.</p> <p>STYLE AL</p>

mat'l. code				tolerances unless otherwise specified		CUSTOMER COPY		Electronics www.fciconnect.com	
ltr	ecn no	dr	date	linear	.XX ±.01/3	projection	title		
AY				linear	.XXX ±.005/0.13	 INCH/MM	MINI LATCH HOUSING		
				angles	.XXX ±.0020/0.051		DOUBLE ROW .100/2.54 C.C.		
				dr	M. CLOUSER 1/31/91	scale	product family	LATCH HOUSINGS (67)	code
				engr	C. TREXLER 1/31/91	1:1	size	dwg no	sheet
				chr	C. TREXLER 1/31/91		A	65043	4 of
				appd	C. TREXLER 1/31/91				
sheet index	revision sheet						cage code	22526	

PRODUCT NO
SEE TABLE

MARK FIRST AND LAST POSITION WITH APPROPRIATE NO. ON ONE SIDE. ALSO PRINT "THIS SIDE UP-2" AS SHOWN.

STYLE AM

MARK NUMBERS IN WHITE

STYLE AP

DATE CODE

MARK DESC P/N, CAGE NO., DATE CODE IN AREA'S SHOWN. NOTE 8 & 9

STYLE AN

MARK NUMBERS IN WHITE

STYLE AR

Tous droits strictement reserves. Reproduction ou communication a des tiers interdite sous quelque forme que ce soit sans autorisation écrite du propriétaire. Property of FCI. Droits de reproduction FCI.



ALL rights strictly reserved. Reproduction or issue to third parties in any form whatever is not permitted without written authority from the proprietor. Property of FCI. Copyright FCI.

mat'l. code		tolerances unless otherwise specified		CUSTOMER COPY		Electronics www.fciconnect.com	
ltr	ecn no	dr	date	linear	.XX ±.01/.3	projection	
AY					.XXX ±.005/0.13	INCH/MM	
				angles	.XXX ±.0020/0.051	scale	title MINI LATCH HOUSING DOUBLE ROW .100/2.54 C.C. product family LATCH HOUSINGS (67) code size dwg no 65043 sheet 5 of
				dr	0° ±2'	1:1	
				engr	M. CLOUSER 1/31/91		
				chr	C. TREXLER 1/31/91		
				appd	C. TREXLER 1/31/91		
sheet index	revision sheet						

cage code
22526

Tous droits strictement réservés. Reproduction ou communication à des tiers interdite sous quelque forme que ce soit sans autorisation écrite du propriétaire. Propriété de c FCI. Droits de reproduction FCI.

All rights strictly reserved. Reproduction or issue to third parties in any form whatever is not permitted without written authority from the proprietor. Property of FCI. Copyright FCI.

PRODUCT NO.	NO OF POS	DIM K	SPECIAL MARKINGS STYLE	CUSTOMER RESTRICTED
65043-001	2 X 36	3.600/91.44		
-002	2 X 35	3.500/88.90		
-003	2 X 34	3.400/86.36		
-004	2 X 33	3.300/83.82		
-005	2 X 32	3.200/81.28		
-006	2 X 31	3.100/78.74		
-007	2 X 30	3.000/76.20		
-008	2 X 29	2.900/73.66		
-009	2 X 28	2.800/71.12		
-010	2 X 27	2.700/68.58		
-011	2 X 26	2.600/66.04		
-012	2 X 25	2.500/63.50		
-013	2 X 24	2.400/60.96		
-014	2 X 23	2.300/58.24		
-015	2 X 22	2.200/55.88		
-016	2 X 21	2.100/53.34		
-017	2 X 20	2.000/50.80		
-018	2 X 19	1.900/48.26		
-019	2 X 18	1.800/45.72		
-020	2 X 17	1.700/43.18		
-021	2 X 16	1.600/40.64		
-022	2 X 15	1.500/38.10		
-023	2 X 14	1.400/35.56		
-024	2 X 13	1.300/33.02		
-025	2 X 12	1.200/30.48		
-026	2 X 11	1.100/27.94		
-027	2 X 10	1.000/25.40		
-028	2 X 9	.900/22.86		
-029	2 X 8	.800/20.32		
-030	2 X 7	.700/17.78		
-031	2 X 6	.600/15.24		
-032	2 X 5	.500/12.70		
-033	2 X 4	.400/10.16		
-034	2 X 3	.300/7.62		
65043-035	2 X 2	.200/5.08		

FCI

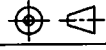
mat'l. code		tolerances unless otherwise specified		CUSTOMER COPY		 Electronics FCI www.fciconnect.com	
ltr	ecn no	dr	date	linear	.XX ±.01/3	projection	title
AY					.XXX ±.005/0.13		MINI LATCH HOUSING
				angles	.XXXX ±.0020/0.051		DOUBLE ROW .100/2.54 C.C.
				dr	0° ±2°	INCH/MM	product family
				enr	M. CLOUSER 1/31/91	scale	LATCH HOUSINGS (67)
				chr	C. TREXLER 1/31/91	1:1	code
				appd	C. TREXLER 1/31/91	A	size
sheet index	revision sheet						dwg no
							65043
							sheet
							6 of

Tous droits strictement réservés. Reproduction ou communication à des tiers interdite sous quelque forme que ce soit sans autorisation écrite du propriétaire. Propriété de c FCI. Droits de reproduction FCI.

All rights strictly reserved. Reproduction or issue to third parties in any form whatever is not permitted without written authority from the proprietor. Property of FCI. Copyright FCI.



MILITARY PRODUCT NO.	MADE FROM	MARKING STYLE	DESC P/N	CAGE NO.
65043-001 -MIL	65043-001	AN	86038-72	22526
-002	-002		-70	
-003	-003		-68	
-004	-004		-66	
-005	-005		-64	
-006	-006		-62	
-007	-007		-60	
-008	-008		-58	
-009	-009		-56	
-010	-010		-54	
-011	-011		-52	
-012	-012		-50	
-013	-013		-48	
-014	-014		-46	
-015	-015		-44	
-016	-016		-42	
-017	-017		-40	
-018	-018		-38	
-019	-019		-36	
-020	-020		-34	
-021	-021		-32	
-022	-022		-30	
-023	-023		-28	
-024	-024		-26	
-025	-025		-24	
-026	-026		-22	
-027	-027		-20	
-028	-028		-18	SEE NOTE 9
-029	-029		-16	
-030	-030		-14	
-031	-031		-12	
-032	-032		-10	
-033	-033		-08	
-034	-034		-06	
65043-035 -MIL	65043-035	AN	86038-04	22526

SEE NOTE 9

SEE NOTE 9

mat'l. code				tolerances unless otherwise specified		CUSTOMER COPY		Electronics FCI www.fciconnect.com	
ltr	ecn no	dr	date	linear	.XX ±.01/.3	projection	title		
AY					.XXX ±.005/0.13		MINI LATCH HOUSING		
				angles	.XXX ±.0020/0.051	INCH/MM	DOUBLE ROW .100/2.54 C.C.		
					0° ±2'	scale	product family	LATCH HOUSINGS (67)	code
				dr	M. CLOUSER 1/31/91	1:1	size	dwg no	sheet
				enr	C. TREXLER 1/31/91		A	65043	7 of
				chr	C. TREXLER 1/31/91				
				appd	C. TREXLER 1/31/91				
sheet index	revision sheet								

cage code 22526

ACAD

PDM: Rev:AY

STATUS: Released

Printed: Aug 02, 2002

Tous droits strictement reserves. Reproduction ou communication a des tiers interdite sous quelque forme que ce soit sans autorisation ecrite du proprietaire. Propriete de FCI. Droits de reproduction FCI.

All rights strictly reserved. Reproduction or issue to third parties in any form whatever is not permitted without written authority from the proprietor. Property of FCI. Copyright FCI.

PRODUCT NO.	NO OF POS	DIM K	SPECIAL MARKINGS STYLE	CUSTOMER RESTRICTED
65043-037	2 X 13	1.300/33.02	A	*
-038	2 X 22	2.200/55.88	B	
-039	2 X 12	1.200/30.48	C	
-040	2 X 16	1.600/40.64	C	
-041	2 X 20	2.000/50.80	C	
-042	2 X 24	2.400/60.96	C	
-043	2 X 4	.400/10.16	C	
-044	2 X 8	.800/20.32	C	
-045	2 X 30	3.000/76.20	D	
-046	2 X 10	1.000/25.40	E	
-047	2 X 13	1.300/33.02	E	
-048	2 X 20	2.000/50.80	F	*
-049	2 X 10	1.000/25.40	F	*
-050	2 X 15	1.500/38.10	C	
-051	2 X 2	.200/5.08	C	*
-052	2 X 13	1.300/33.02	K	*
-053	2 X 3	.300/7.62	L	*
-054	2 X 15	1.500/38.10	J	*
-055	2 X 22	2.200/55.88	G	*
-056	2 X 20	2.000/50.80	H	*
-057	2 X 20	2.000/50.80	E	
-058	2 X 5	.500/12.70	M	*
-059	2 X 6	.600/15.24	M	*
-060	2 X 10	1.000/25.40	M	*
-061	2 X 13	1.300/33.02	M	*
-062	2 X 16	1.600/40.64	M	*
-063	2 X 17	1.700/43.18	M	*
-064	2 X 20	2.000/50.80	M	*
-065	2 X 4	.400/10.16	N	
-066	2 X 14	1.400/35.56	E	
-067	2 X 13	1.300/33.02	G	*
-068	2 X 17	1.700/43.18	G	*
-069	2 X 20	2.000/50.80	G	*
-070	2 X 12	1.200/30.48	O	
65043-071	2 X 19	1.900/48.26	O	

FCI

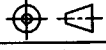
mat'l. code		tolerances unless otherwise specified		CUSTOMER COPY		 Electronics FCI www.fciconnect.com	
ltr	ecn no	dr	date	linear	.XX ±.01/.3	projection	title MINI LATCH HOUSING DOUBLE ROW .100/2.54 C.C.
AY					.XXX ±.005/0.13		
				angles	.XXXX ±.0020/0.051		
				dr	M. CLOUSER 1/31/91	INCH/MM	
				enr	C. TREXLER 1/31/91	scale	
				chr	C. TREXLER 1/31/91	1:1	
				appd	C. TREXLER 1/31/91		
sheet index	revision sheet						

cage code
22526

PRODUCT NO.	NO OF POS	DIM K	SPECIAL MARKINGS STYLE	CUSTOMER RESTRICTED
65043-072	2 X 22	2.200/55.88	O	
-073	2 X 27	2.700/68.58	P	
-074	2 X 10	1.000/25.40	Q	
-075	2 X 10	1.000/25.40	O	
-076	2 X 10	1.000/25.40	M	
-077	2 X 22	2.200/55.88	R	
-078	2 X 20	2.000/50.80	R	
-079	2 X 6	.600/15.24	R	
-080	2 X 8	.800/20.32	R	
-081	2 X 7	.700/17.78	R	
-082	2 X 11	1.100/27.94	R	
-083	2 X 12	1.200/30.48	R	
-084	2 X 20	2.000/50.80	O	
-085	2 X 10	1.000/25.40	R	
-086	2 X 19	1.900/48.26	C	
-087	2 X 10	1.000/25.40	C	
-088	2 X 5	.500/12.70	C	
-089	2 X 3	.300/7.62	N	
-090	2 X 9	.900/22.86	O	
-091	2 X 13	1.300/33.02	O	
-092	2 X 13	1.300/33.02	S	
-093	2 X 3	.300/7.62	T	
-094	2 X 11	1.100/27.94	U	
-095	2 X 13	1.300/33.02	V	
-096	2 X 13	1.300/33.02	W	
-097	2 X 13	1.300/33.02	M	
-098	2 X 25	2.500/63.50	M	*
-099	2 X 4	.400/10.16	O	
-100	2 X 13	1.300/33.02	Y	
-101	2 X 7	.700/17.78	Z	
-102	2 X 22	2.200/55.88	Z	
-103	2 X 26	2.600/66.04	Z	
-104	2 X 32	3.200/81.28	Z	
-105	2 X 10	1.000/25.40	Z	
65043-106	2 X 8	.800/20.32	Z	

Tous droits strictement reserves. Reproduction ou communication a des tiers interdite sous quelque forme que ce soit sans autorisation ecrite du proprietaire. Propriete de c FCI. Droits de reproduction FCI.

All rights strictly reserved. Reproduction or issue to third parties in any form whatever is not permitted without written authority from the proprietor. Property of FCI. Copyright FCI.

FCI

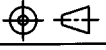
mat'l. code				tolerances unless otherwise specified			CUSTOMER COPY		 Electronics www.fciconnect.com	
ltr	ecn no	dr	date	linear	.XX ±.01/.3		projection	title		
AY					.XXX ±.005/0.13			MINI LATCH HOUSING		
					.XXXX ±.0020/0.051			DOUBLE ROW .100/2.54 C.C.		
				angles	0° ±2'		 INCH/MM scale 1:1	product family LATCH HOUSINGS (67)		code
				dr	M. CLOUSER	1/31/91		size dwg no		-
				enrg	C. TREXLER	1/31/91		A		sheet
				chr	C. TREXLER	1/31/91		65043		9 of
				appd	C. TREXLER	1/31/91				
sheet index	revision sheet									

PRODUCT NO	NO OF POS	DIM K	SPECIAL MARKINGS STYLE	CUSTOMER RESTRICTED
65043-107	2 X 5	.500/12.70	Z	
-108	2 X 15	1.500/38.10	Z	
-109	2 X 30	3.000/76.20	Z	
-110	2 X 13	1.300/33.02	Z	
-111	2 X 2	.200/5.08	AA	
-112	2 X 5	.500/12.70	AA	
-113	2 X 6	.600/15.24	AA	
-114	2 X 7	.700/17.78	AA	
-115	2 X 8	.800/20.32	AA	
-116	2 X 7	.700/17.78	AB	*
-117	2 X 7	.700/17.78	O	
-118	2 X 13	1.300/33.02	C	
-119	2 X 13	1.300/33.02	AC	
-120	2 X 2	.200/5.08	Z	
-121	2 X 4	.400/10.16	Z	
-122	2 X 17	1.700/43.18	Z	
-123	2 X 20	2.000/50.80	Z	
-124	2 X 8	.800/20.32	O	
-125	2 X 15	1.500/38.10	D	
-126	2 X 30	3.000/76.20	Y	
-127	2 X 15	1.500/38.10	AD	
-128	2 X 32	3.200/81.28	AD	
-129	2 X 15	1.500/38.10	AE	
-130	2 X 32	3.200/81.28	AE	
-131	2 X 22	2.200/55.88	AF	
-132	2 X 7	.700/17.78	AF	
-133	2 X 19	1.900/48.26	AF	
-134	2 X 12	1.200/30.48	AF	
-135	2 X 15	1.500/38.10	M	
-136	2 X 12	1.200/30.48	Z	
-137	2 X 18	1.800/45.72	Z	
-138	2 X 25	2.500/63.50	Z	
-139	2 X 36	3.600/91.44	Z	
-140	2 X 15	1.500/38.10	AG	
65043-141	2 X 7	.700/17.78	AG	

Tous droits strictement reserves. Reproduction ou communication a des tiers interdite sous quelque forme que ce soit sans autorisation écrite du propriétaire. Propriete de c FCI. Droits de reproduction FCI.

All rights strictly reserved. Reproduction or issue to third parties in any form whatever is not permitted without written authority from the proprietor. Property of FCI. Copyright FCI.



mat'l. code		tolerances unless otherwise specified		CUSTOMER COPY		Electronics www.fciconnect.com	
ltr	ecn no	dr	date	linear	.XX ±.01/.3	projection	title
AY					.XXX ±.005/0.13		MINI LATCH HOUSING
				angles	.XXX ±.0020/0.051		DOUBLE ROW .100/2.54 C.C.
					0° ±2'	INCH/MM	product family LATCH HOUSINGS (67)
				dr	M. CLOUSER 1/31/91	scale	code
				enr	C. TREXLER 1/31/91	1:1	-
				chr	C. TREXLER 1/31/91		sheet
				appd	C. TREXLER 1/31/91		10 of
sheet index	revision sheet						

Tous droits strictement réservés. Reproduction ou communication à des tiers interdite sous quelque forme que ce soit sans autorisation écrite du propriétaire. Propriété de c FCI. Droits de reproduction FCI.

All rights strictly reserved. Reproduction or issue to third parties in any form whatever is not permitted without written authority from the proprietor. Property of FCI. Copyright FCI.

PRODUCT NO	NO OF POS	DIM K	SPECIAL MARKINGS STYLE	CUSTOMER RESTRICTED
65043-142	2 X 7	.700/17.78	D	
-143	2 X 3	.300/7.62	Y	
-144	2 X 5	.500/12.70	Y	
-145	2 X 10	1.000/25.40	Y	
-146	2 X 12	1.200/30.48	Y	
-147	2 X 13	1.300/33.02	Y	
-148	2 X 15	1.500/38.10	Y	
-149	2 X 17	1.700/43.18	Y	
-150	2 X 18	1.800/45.72	Y	
-151	2 X 20	2.000/50.80	Y	
-152	2 X 25	2.500/63.50	Y	
-153	2 X 35	3.500/88.90	Y	
-154	2 X 36	3.600/91.44	Y	
-155	2 X 30	3.000/76.20	E	
-156	2 X 13	1.300/33.02	AH	
-157	2 X 14	1.400/35.56	AJ	
-158	2 X 12	1.200/30.48	AK	
-159	2 X 27	2.700/68.58	D	
-160	2 X 12	1.200/30.48	E	
-161	2 X 24	2.400/60.96	E	
-162	2 X 12	1.200/30.48	D	
-163	2 X 4	.400/10.16	AG	
-164	2 X 23	2.300/58.42	AJ	
-165	2 X 7	.700/17.78	AJ	
-166	UNAVAILABLE			
-167	UNAVAILABLE			
-168	UNAVAILABLE			
-169	UNAVAILABLE			
-170	UNAVAILABLE			
-171	2 X 9	.900/22.86	AP	
65043-172	2 X 9	.900/22.86	AR	



mat'l. code		tolerances unless otherwise specified		CUSTOMER COPY		Electronics www.fciconnect.com				
ltr	ecn no	dr	date	linear	.XX ±.01/3	projection		title		
AY					.XXX ±.005/0.13				INCH/MM	MINI LATCH HOUSING DOUBLE ROW .100/2.54 C.C. product family LATCH HOUSINGS (67)
					.XXXX ±.0020/0.051					
				angles	0° ±2'	scale	A	size 65043 sheet 11 of		
				dr	M. CLOUSER 1/31/91				1:1	A
				enr	C. TREXLER 1/31/91					
				chr	C. TREXLER 1/31/91					
				appd	C. TREXLER 1/31/91					
sheet index	revision sheet									

cage code 22526